

Model №	913	920	926
---------	-----	-----	-----

PRO

MAGNUM SHEAR™

I-SERIES

FOR FLOORING, SIDING & MORE!

INSTRUCTION MANUAL ▶
READ BEFORE USE!



BULLET TOOLS™
The Professional's Best Shot™





WARNING: FAILURE TO FOLLOW THESE RULES MAY RESULT IN SERIOUS INJURY! USING THIS MACHINE WITH RESPECT AND CAUTION WILL CONSIDERABLY LESSEN THE POSSIBILITY OF PERSONAL INJURY.

SAFETY RULES FOR THE MAGNUM SHEAR™

1.**READ AND UNDERSTAND THIS INSTRUCTION MANUAL BEFORE OPERATING THE MAGNUM SHEAR™.**
2.If you are not thoroughly familiar with the operation of the Magnum Shear™, obtain advice from a qualified instructor or call 800-406-8998 (International: 208-772-0175).
3.Stay alert. Do not operate while under the influence of drugs, alcohol, or medication.
4.Always wear safety approved eye protection with side shields (ANSI Z87.1).
5.Keep work area clean and free of debris.
6.Keep children and unauthorized persons away from Magnum Shear™ and work area.
7.Make sure tool is secure. Operate only on a firm substrate or solid stand.
8.Use the right tool. Do not force the Magnum Shear™ or use it for a job for which it was not designed; use only on approved materials (see list on p. 9).
9.Keep Blade sharp. A dull Blade will not perform properly.
10.Always keep hands away from Blade while operating or carrying.
11.Do not alter or misuse this tool. The Magnum Shear™ is precision built; modifications not specified in this manual may result in a dangerous condition.
12.Maintain Magnum Shear™ with care. Keep Blade sharp and clean. Follow instructions for lubricating and changing accessories.
13.Use only recommended accessories. The use of improper accessories may cause hazards or injury.
14.Never leave the Magnum Shear™ unattended. Secure the Handle with the Safety Lock when not in use (see p. 4).
15.Warning: The dust generated by cutting certain wood, wood fiber and/or PVC products can be injurious to your health (*but since the Magnum Shear™ doesn't create any dust, we suggest that you don't eat the small chips sometimes created when cutting*).



! WARNING
VERY SHARP BLADE

SET UP

Welcome! Your Magnum Shear™ comes ready to easily assemble*.

Please Review Parts Included in Box:

*Note: You will need #2 & #3 Phillips head screwdrivers

1. Power Assembly
2. Handle Assembly
3. Fence
4. Table
5. Tail
6. Rails (2)
7. Instruction Manual
8. Hone Stone
9. 10mm Hex Wrench
10. Hardware Kit containing

- part A. (4) 8mm x 60mm PH Phillips machine screws
 part B. (4) M8 star washers
 part C. (4) 8mm x 25mm PH Phillips machine screws
 part D. (6) 6mm x 16mm PH Phillips machine screws
 part E. (5) #12 x 1 PH Phillips tapping screws

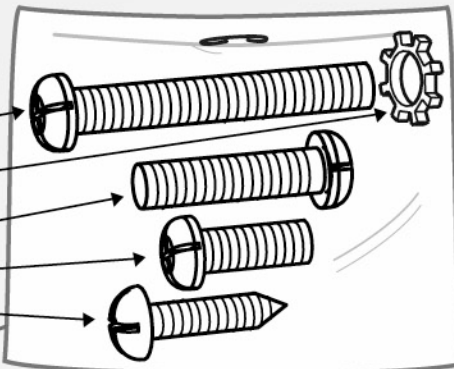

ASSEMBLY

1 ATTACH

rails to power assembly using (4) 8mm x 60mm PH Phillips machine screws fitted with M8 star washers. (Hardware Kit part A. & B.)

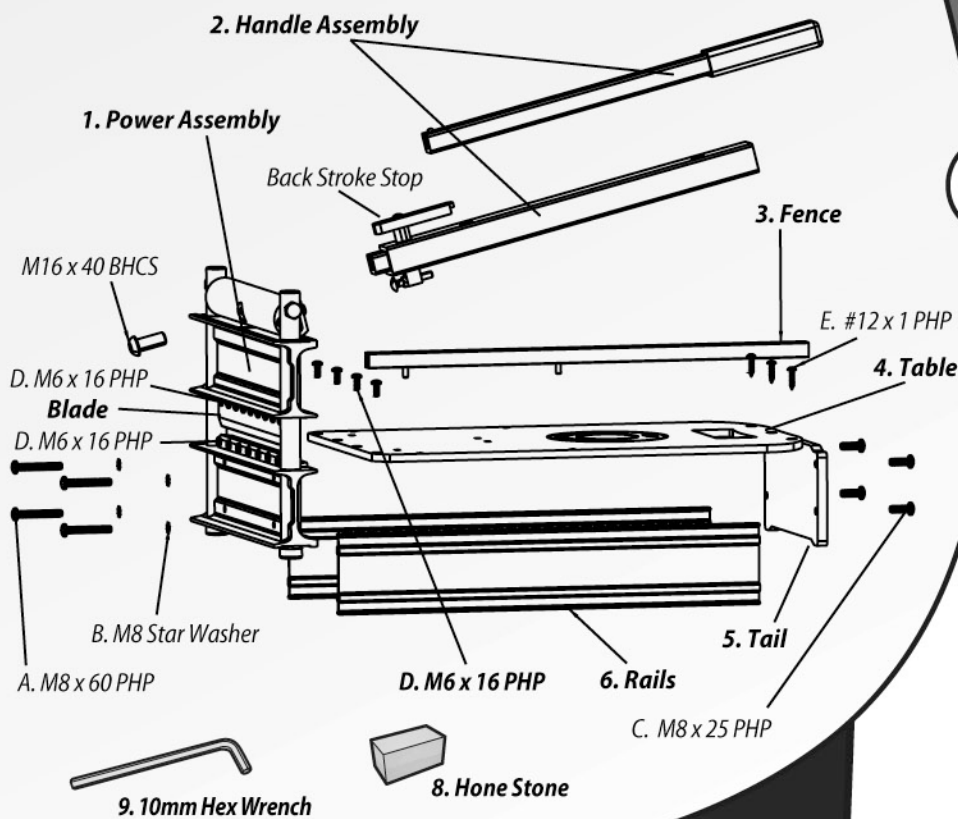
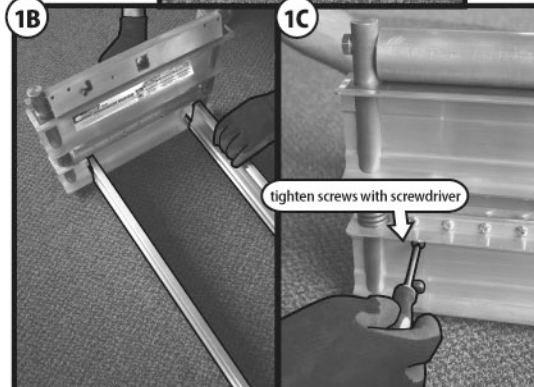
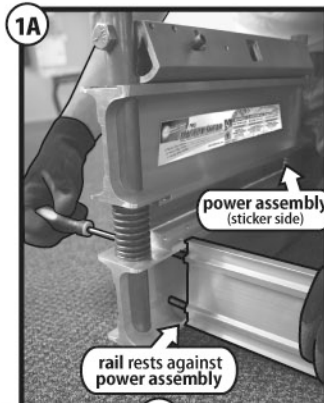

2

ATTACH

tail to rails using (4) 8mm x 25mm PH Phillips machine screws (Hardware Kit part C.). Make sure holes in tail are facing up.

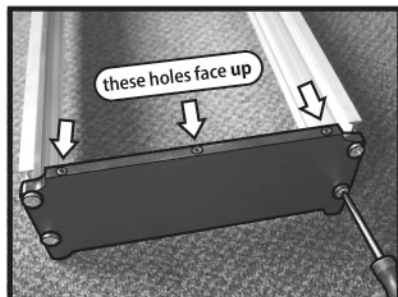

SET UP



3 ATTACH TABLE to power assembly, starting with front, use 4 (for the I-13), 5 (for the I-20), or 6 (for the I-26) 6mm x 16mm PH Phillips machine screws (Hardware Kit part D. ).

3A Next, attach back of table to tail using 3 (for the I-13), 4 (for the I-20), or 5 (for the I-26) #12 x 1" PH Phillips tapping screws (Hardware Kit part E. ).

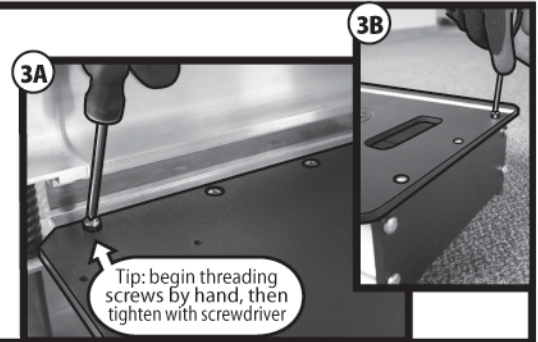

4 TO ATTACH HANDLE,

- Insert handle into cam shaft.
- Note: back stroke stop must face upward!*
- Tighten M16 x 40 bolt (pre-installed in cam shaft) with 10mm hex wrench (included).

NOTE: Do not remove plastic tie until handle is bolted in place

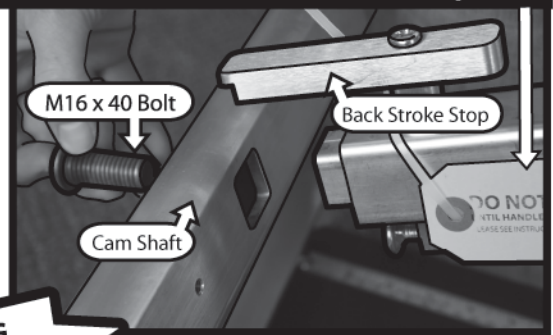

5 PLACE THE FENCE

- Insert fence into one of the six hole sets on the table: there are two 90° and four 45° locations
- The fence is friction fit (requires effort to insert or remove)

WARNING
HANDLE UNDER EXTREME PRESSURE - DO NOT ALLOW TO SLAM BACK!

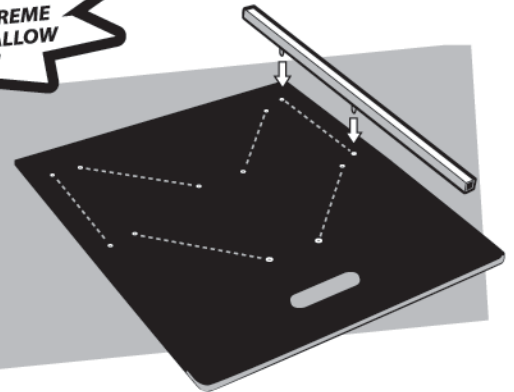

OPTIONAL ACCESSORIES

are available, such as Castors (#848-I) and a new Angle Guide Kit (#856AG) . See p. 10 for more information.

SAFETY LOCK

6 For maximum security, the Safety Lock will **AUTOMATICALLY RESET** in the "locked" position (A) unless disengaged. *Note: You must pull Safety Lock IN each time you make a cut.*

The Safety Lock can be **DISENGAGED** by pulling the knob **IN** and hooking into slot as shown below (B).

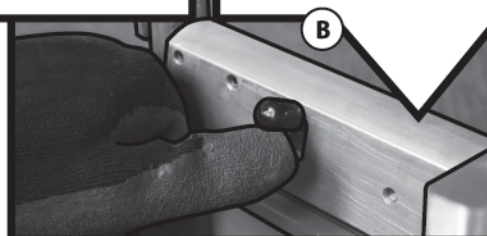
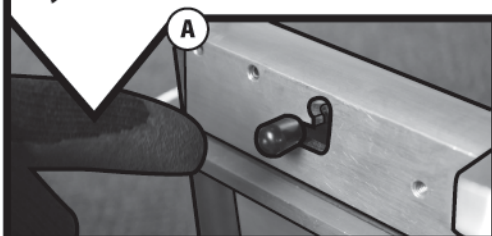

Note: It is important to RE-ENGAGE LOCK AND SECURE HANDLE in down position while storing, carrying, or transporting the Magnum Shear™.



MAKING CUTS

Your Magnum Shear™ is **OPERATED MANUALLY**. The two-part handle is grasped by the operator and pushed down to make a cut.

USE EXTREME CAUTION! Blade is very sharp!



1 Unlock Safety Lock by pulling knob **IN** (see p. 4).

2 Insert material. It is recommended that you **HOLD MATERIAL IN PLACE** until the cut is complete.
ALWAYS KEEP HANDS AWAY FROM BLADE while operating or carrying!

3 **PUSH HANDLE DOWN** to cut. Some effort may be required, depending on hardness of material. *ALWAYS KEEP HANDS AWAY FROM BLADE while operating!*

WARNING
It is advised that protective gloves and goggles are worn when operating the Magnum Shear™

4 **MAINTAIN CONTROL OF HANDLE!**
DO NOT ALLOW HANDLE TO SLAM BACK AFTER MAKING A CUT.

WARNING
HANDLE UNDER EXTREME PRESSURE - DO NOT ALLOW TO SLAM BACK!

HONING A burr may form on the flat side of the Blade within the first 30-100 cuts; this is normal. Use the Hone Stone (included) to remove burr (see p. 7, #2).

5 Most materials (listed on p. 9) shear very well with just one cut. However, some brands of laminate flooring and other products may require cutting twice to produce a better cut.

DOUBLE CUTTING : Simply make your first cut 1/8" to 1/4" (3 to 6 mm) longer than your mark, then go back and make your second cut on your mark. This is very useful to create a cleaner cut when a trim molding or transition cannot be used to cover your cut end.

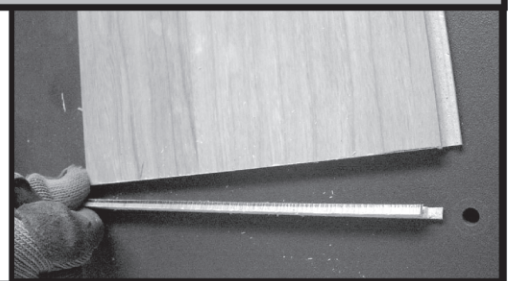

CUSTOM SETTINGS



THICKNESS

1

TO CUT APPROVED PRODUCTS **OVER 3/4" THICK** (see p. 9), loosen and remove Phillips head screw on the "back stroke stop"; turn the "back stroke stop" 180° and replace and tighten Phillips head screw. For more convenience when cutting thinner products, restore factory setting.

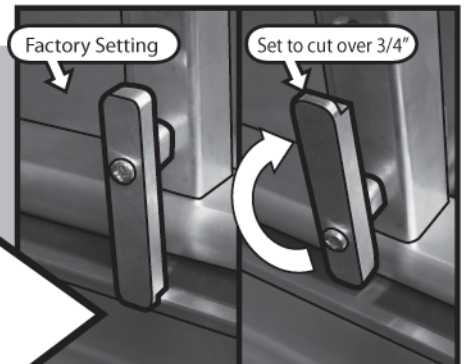

SUPPORT

2

THE ANVIL has 2 edges: a 1/32" (0.75mm) narrow edge and a 3/16" (4.5mm) wide edge. Either edge can be used according to the support needed to make a clean cut (some soft-backed products require the wider anvil setting).

TO CHANGE the anvil setting, remove the M6 x 16 PHP Screws and flip the anvil over.

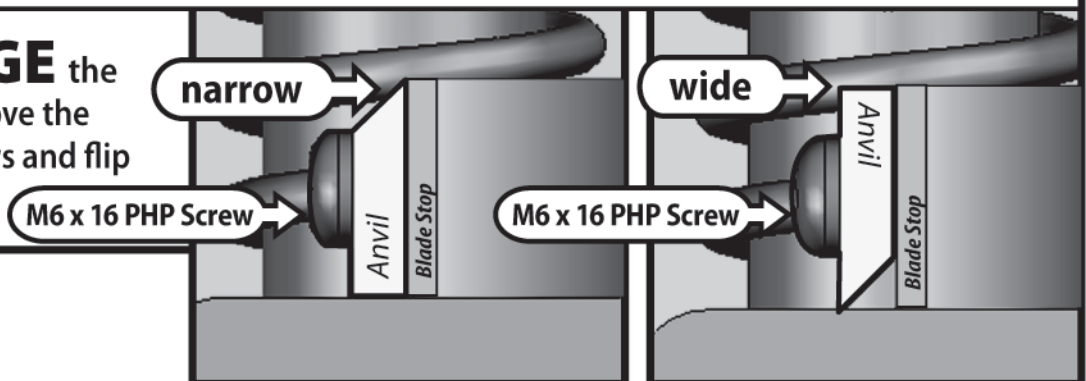

BLADE DEPTH

3

You may need to adjust the depth of the blade to cut all the way through your product. You can do this by

ADJUSTING THE STOP SCREW:

- A** Loosen the stop screw nut and turn stop screw until it is loose. Release handle to open blade.
- B** Push the handle down until the blade is resting on the "blade stop" (see p. 8, #6).
- C** Adjust the stop screw until it makes contact with the power assembly. Tighten the stop screw nut.

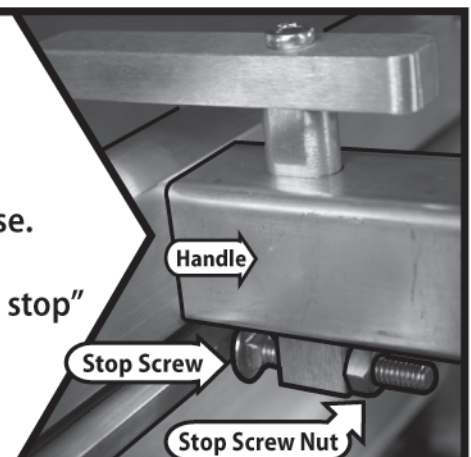

CAUTION: DO NOT OPERATE WITHOUT STOP SCREW IN PLACE - MAKE SURE IT IS SET CORRECTLY.



MAINTENANCE

THE BLADE

1

The blade must be **PLACED WITH FLAT SIDE** toward the table side in power assembly pocket. **USE ONLY I-SERIES (PREMIUM) BLADES IN I-SERIES MAGNUM SHEARS™.** Any other blade will not perform properly and may damage your machine.

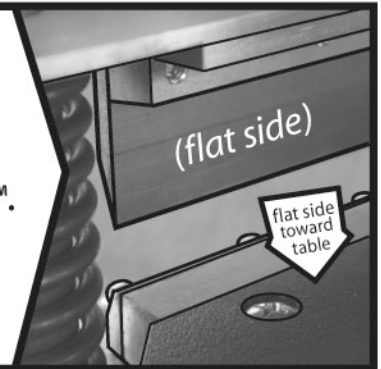

HONING THE BLADE

2

There are **three situations** when it is very important to hone the blade (remove burrs) on the flat side of the blade:

- 1 After the first 30-100 cuts on a new blade
- 2 Every 100+ cuts on the job
- 3 When the blade has been re-sharpened

CAUTION! USE HAND PROTECTION! BLADE IS VERY SHARP!

TO HONE:

With the blade in the machine, it is quick and easy to hone; Simply pull the Magnum Shear™ handle down until the blade is **just above the blade stop** (approximately 1/8"). Then, lay the **wide flat side of the hone stone** against the **flat side of the blade** and move hone stone from end to end 2 to 3 times to remove any burrs.

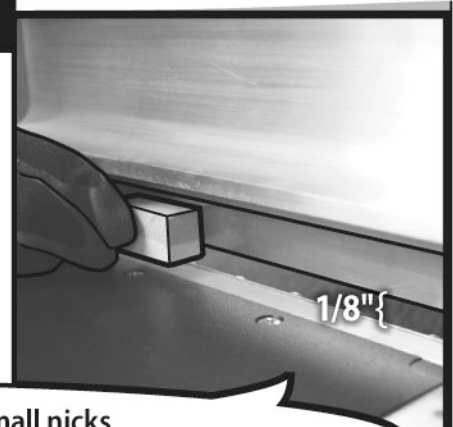

Notice: It is not necessary to remove the small nicks or chips from the blade edge when sharpening or honing.

SHARPENING THE BLADE

3

The blade can be sharpened to restore a one-sided, 21°-22° knife edge. It is important to note that the **blade must be sharpened only on the beveled side**, leaving the flat side flat.

We recommend that power grinding only be done professionally, as the blade must be fluid cooled during this process.



MAINTENANCE



CHANGING THE BLADE

4

WARNING!

**BLADE IS EXTREMELY SHARP!
USE HAND PROTECTION WHEN REMOVING,
HONING, OR SHARPENING BLADE!**

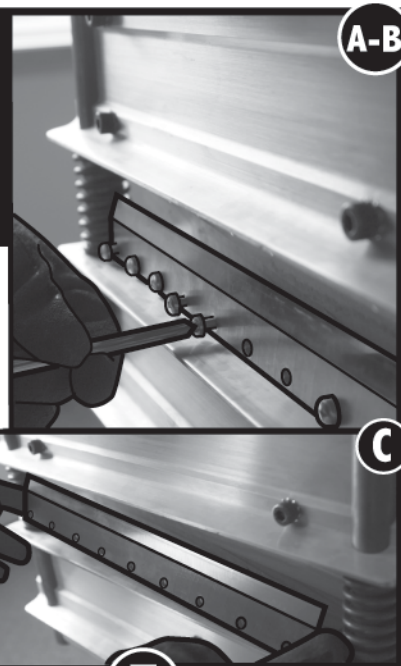

A

TURN THE MAGNUM SHEAR™ UPSIDE DOWN

Tip: Set the Magnum Shear™ on the edge of a sturdy bench or table

B

LOOSEN THE BLADE:

Using a Phillips screwdriver, remove the M6 X 16 PHP screws.

C

TO REMOVE BLADE:

hold blade by each end and carefully lift out of blade pocket.

D

TO INSTALL BLADE:

Hold blade by each end and carefully place into the blade pocket in the power assembly, with the flat side of the blade facing the table. *Be sure that it is firmly seated and that the pocket is clear of debris.*

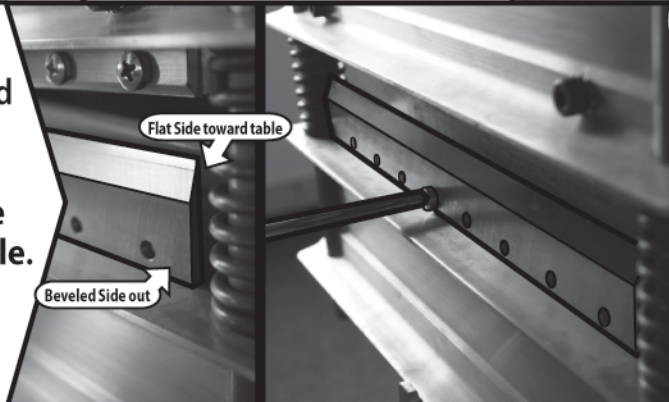

E

TIGHTEN THE

BLADE: Using a Phillips screwdriver, replace & tighten the M6 x 16 PHP screws, starting with the center screw.

PREVENTING CORROSION

5

It is important to spray a fine layer of light oil (10W motor oil or WD-40®) over the Power Assembly at the points indicated once every month to prevent surface corrosion.

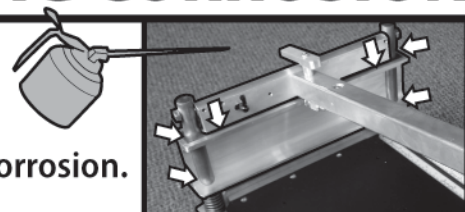

THE "BLADE STOP"

6

The "blade stop" may eventually become worn. You can remove the anvil and turn "blade stop" over for more use. Replacements can be purchased from your dealer.

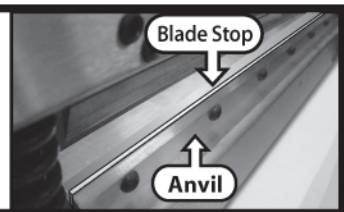



CUTTING INFORMATION

ACCEPTABLE MATERIALS & SIZE LIMITATIONS

FOR THE PRO MAGNUM SHEAR™ I SERIES WITH THE PREMIUM BLADE				
Material	Max. Thickness	PRO I-13 Max Width	PRO I-20 Max Width	PRO I-26 Max Width
Carpet Tile	18mm or 3/4inch	13 inches	20 inches	26 inches
Commercial Vinyl	24mm or 1 inch	13 inches	20 inches	26 inches
Cork	24mm or 1 inch	13 inches	20 inches	26 inches
DuraStone™	6mm or 1/4 inch	13 inches	20 inches	26 inches
Laminate Flooring	15mm or 5/8 inch	13 inches	16 inches	16 inches
Leather	24mm or 1 inch	13 inches	20 inches	26 inches
Luxury Vinyl Tile	24mm or 1 inch	13 inches	20 inches	26 inches
Parquet	12mm or 1/2 inch	13 inches	20 inches	26 inches
PermaStone™	6mm or 1/4 inch	13 inches	20 inches	26 inches
PVC Tile	24mm or 1 inch	13 inches	20 inches	26 inches
Recycled Tire Tile	24mm or 1 inch	13 inches	20 inches	26 inches
Rubber Cove Base	12mm or 1/2 inch	13 inches	20 inches	26 inches
Rubber Tile	24mm or 1 inch	13 inches	20 inches	26 inches
Soft Plastic	24mm or 1 inch	13 inches	20 inches	26 inches
Tirex™ & Rope Cord	24mm or 1 inch	13 inches	20 inches	26 inches
Siding, Fiber Cement Board	12mm or 1/2inch	13 inches	20 inches	26 inches
Siding, Pressboard Lap	18mm or 3/4inch	13 inches	20 inches	26 inches
Siding, Vinyl	24mm or 1 inch	13 inches	20 inches	26 inches
Siding, Wood	24mm or 1 inch	13 inches	20 inches	26 inches
Shingles, Tar or Wood	12mm or 1/2inch	13 inches	20 inches	26 inches
VCT Tile	18mm or 3/4inch	13 inches	20 inches	26 inches
Wood Flooring, Eng. (most)	18mm or 3/4inch	8 inches	8 inches	8 inches
Wood Flooring, Solid (most)	18mm or 3/4inch	4 inches	4 inches	n/a

PLEASE NOTE:
ACCEPTABLE MATERIALS MAY VARY, depending on density and hardness. If extreme pressure is required to cut a product, please contact Bullet Tools™ before proceeding.

THE HARDNESS OF SOLID WOOD

Our Magnum Shears™ cut a wide variety of products, but we recommend cutting solid wood flooring no harder than 1250 on the Janka scale and engineered wood flooring no harder than 1400. See the chart at left for an example of hardness ratings*.

**Please note: due to extreme variations in wood density, the Magnum Shear may or may not cut the hardwoods listed.*

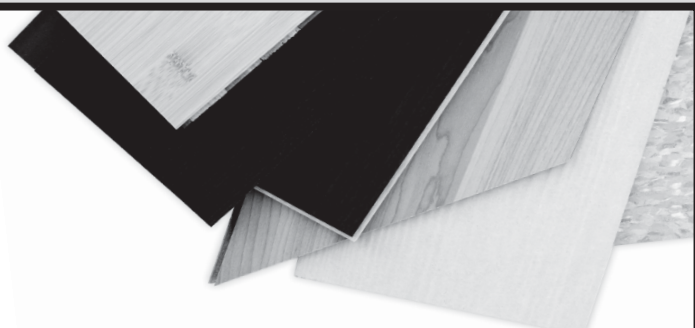
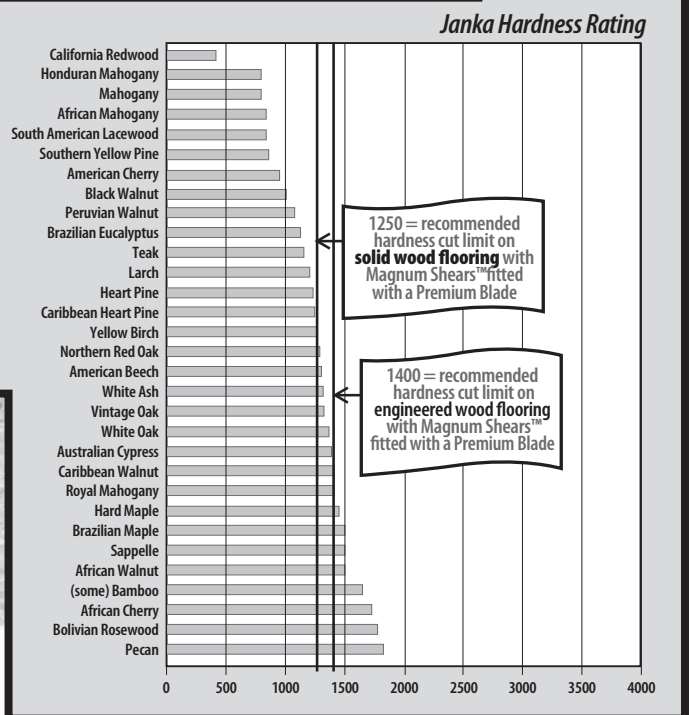

★ AVAILABLE ACCESSORIES

Replacement Premium Blades

for the PRO Magnum Shear™ I-Series & L-Series

#913B 13" Premium Blade

#920B 20" Premium Blade

#926B 26" Premium Blade

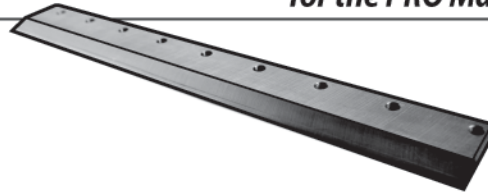

#701S Hone Stone

Keep your blade honed for longer use!

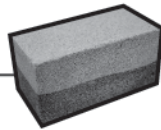

#848-I Castors

Add castors for smooth-rolling portability.

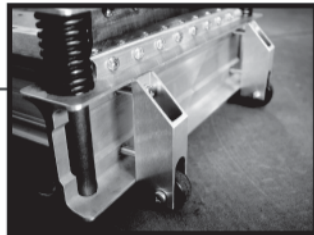

Magnum Shear Stand

#709

Provides a sturdy, raised platform for use or display.



Angle Guide Kit

#856AG-13 #856AG-20 #856AG-26

Provides a fixed "stop" point for more accurate repeat/multiple cuts. Includes 45° Angle Guide with Fence upgrade. Sized specifically for the 13", 20", & 26" Magnum Shears.

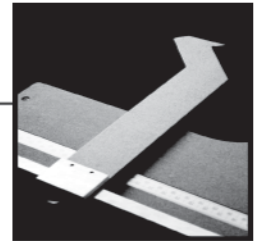

#701AF All-Angle Fence

Sets to any angle from 0 to 90 degrees.

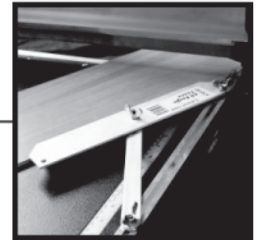

BULLET TOOLS™
The Professional's Best Shot™

