

IMPORTANT:
Read Before Using

IMPORTANT :
Lire avant usage

IMPORTANTE:
Leer antes de usar



Operating/Safety Instructions

Consignes de fonctionnement/sécurité

Instrucciones de funcionamiento y seguridad

MM50

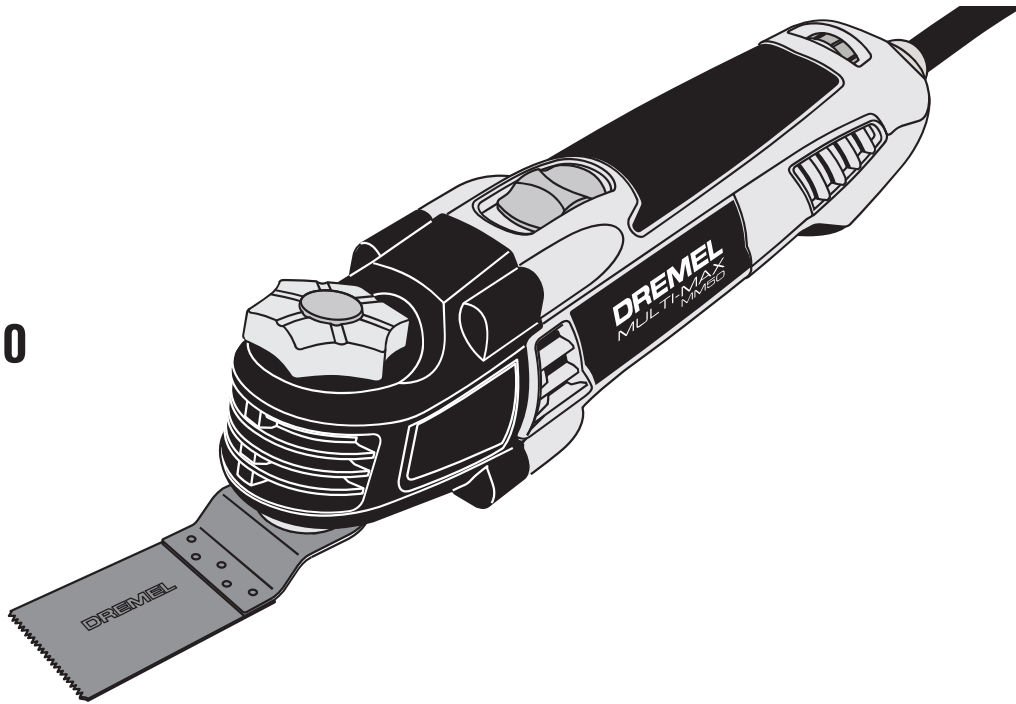

DREMEL®

P.O. Box 081126 Racine, WI 53408-1126

Call Toll Free for
Consumer Information
& Service Locations

Pour obtenir des informations
et les adresses de nos centres
de service après-vente,
appelez ce numéro gratuit

Llame gratis para
obtener información
para el consumidor y
ubicaciones de servicio





1-800-4-DREMEL (1-800-437-3635) www.dremel.com

For English Version
See page 2

Version française
Voir page 20

Versión en español
Ver la página 38

1600A014GX	Instruction manual	AC	6035A06F09	2018-10-09	511	DV	--	MUL	1 / 56
SNR	Term	Ind.	CRNo.	Valid	Release	BWN	DocType	DP	Page / of

Safety Symbols	
The definitions below describe the level of severity for each signal word. Please read the manual and pay attention to these symbols.	
	This is the safety alert symbol. It is used to alert you to potential personal injury hazards. Obey all safety messages that follow this symbol to avoid possible injury or death.
	DANGER indicates a hazardous situation which, if not avoided, will result in death or serious injury.
	WARNING indicates a hazardous situation which, if not avoided, could result in death or serious injury.
	CAUTION indicates a hazardous situation which, if not avoided, could result in minor or moderate injury.

General Power Tool Safety Warnings

⚠️ WARNING Read all safety warnings and all instructions. Failure to follow the warnings and instructions may result in electric shock, fire and/or serious injury.

SAVE ALL WARNINGS AND INSTRUCTIONS FOR FUTURE REFERENCE

The term “power tool” in the warnings refers to your mains-operated (corded) power tool or battery-operated (cordless) power tool.

Work area safety

Keep work area clean and well lit. Cluttered or dark areas invite accidents.

Do not operate power tools in explosive atmospheres, such as in the presence of flammable liquids, gases or dust. Power tools create sparks which may ignite the dust or fumes.

Keep children and bystanders away while operating a power tool. Distractions can cause you to lose control.

Electrical safety

Power tool plugs must match the outlet. Never modify the plug in any way. Do not use any adapter plugs with earthed (grounded) power tools. Unmodified plugs and matching outlets will reduce risk of electric shock.

Avoid body contact with earthed or grounded surfaces such as pipes, radiators, ranges and refrigerators. There is an increased risk of electric shock if your body is earthed or grounded.

Do not expose power tools to rain or wet conditions. Water entering a power tool will increase the risk of electric shock.

Do not abuse the cord. Never use the cord for carrying, pulling or unplugging the power tool. Keep cord away from heat, oil, sharp edges or moving parts. Damaged or entangled cords increase the risk of electric shock.

When operating a power tool outdoors, use an extension cord suitable for outdoor use. Use of a cord suitable for outdoor use reduces the risk of electric shock.

If operating a power tool in a damp location is unavoidable, use a Ground Fault Circuit Interrupter (GFCI) protected supply. Use of an GFCI reduces the risk of electric shock.

Personal safety

Stay alert, watch what you are doing and use common sense when operating a power tool. Do not use a power tool while you are tired or under the influence of drugs, alcohol or medication. A moment of inattention while operating power tools may result in serious personal injury.

1600A014GX	Instruction manual	AC	6035A06F09	2018-10-09	rui1mex	511	DV	--	MUL	2 / 56
SNR	Term	Ind.	CRNo.	Valid	Release	BWN	DocType	CritP.	DP	Page / of

Use personal protective equipment. Always wear eye protection. Protective equipment such as dust mask, non-skid safety shoes, hard hat, or hearing protection used for appropriate conditions will reduce personal injuries.

Prevent unintentional starting. Ensure the switch is in the off-position before connecting to power source and / or battery pack, picking up or carrying the tool. Carrying power tools with your finger on the switch or energizing power tools that have the switch on invites accidents.

Remove any adjusting key or wrench before turning the power tool on. A wrench or a key left attached to a rotating part of the power tool may result in personal injury.

Do not overreach. Keep proper footing and balance at all times. This enables better control of the power tool in unexpected situations.

Dress properly. Do not wear loose clothing or jewelry. Keep your hair, clothing and gloves away from moving parts. Loose clothes, jewelry or long hair can be caught in moving parts.

If devices are provided for the connection of dust extraction and collection facilities, ensure these are connected and properly used. Use of dust collection can reduce dust-related hazards.

Power tool use and care

Do not force the power tool. Use the correct power tool for your application. The correct power tool will do the job better and safer at the rate for which it was designed.

Do not use the power tool if the switch does not turn it on and off. Any power tool that

cannot be controlled with the switch is dangerous and must be repaired.

Disconnect the plug from the power source and/or the battery pack from the power tool before making any adjustments, changing accessories, or storing power tools. Such preventive safety measures reduce the risk of starting the power tool accidentally.

Store idle power tools out of the reach of children and do not allow persons unfamiliar with the power tool or these instructions to operate the power tool. Power tools are dangerous in the hands of untrained users.

Maintain power tools. Check for misalignment or binding of moving parts, breakage of parts and any other condition that may affect the power tool's operation. If damaged, have the power tool repaired before use. Many accidents are caused by poorly maintained power tools.

Keep cutting tools sharp and clean. Properly maintained cutting tools with sharp cutting edges are less likely to bind and are easier to control.

Use the power tool, accessories and tool bits etc. in accordance with these instructions, taking into account the working conditions and the work to be performed. Use of the power tool for operations different from those intended could result in a hazardous situation.

Service

Have your power tool serviced by a qualified repair person using only identical replacement parts. This will ensure that the safety of the power tool is maintained.

Safety Rules for Oscillating Tools

Hold power tool by insulated gripping surfaces, when performing an operation where the cutting accessory may contact hidden wiring or its own cord. Cutting accessory contacting a "live" wire may make exposed metal parts of the power tool "live" and could give the operator an electric shock.

Use clamps or another practical way to secure and support the workpiece to a stable platform. Holding the work by hand or against your body leaves it unstable and may lead to loss of control.

Do not drill, fasten or break into existing walls or other blind areas where electrical

wiring may exist. If this situation is unavoidable, disconnect all fuses or circuit breakers feeding this worksite.

Use a metal detector to determine if there are gas or water pipes hidden in the work area or call the local utility company for assistance before beginning the operation. Striking or cutting into a gas line will result in explosion. Water entering an electrical device may cause electrocution.

Always hold the tool firmly with both hands for maximum control. Keep proper footing and balance at all times. This enables better control of the power tool in unexpected situations.

1600A014GX	Instruction manual	AC	6035A06F09	2018-10-09	511	DV	--	MUL	3 / 56
SNR	Term	Ind.	CRNo.	Valid	Release	BWN	CritP.	DP	Page / of

Keep hands away from cutting area. Do not reach under the material being cut. The proximity of the blade to your hand is hidden from your sight.

Do not use dull or damaged blades. Bent blade can break easily or cause kickback.

Exercise extreme caution when handling the accessories. The accessories are very sharp.

Wear protective gloves when changing cutting accessories. Accessories become hot after prolonged usage.

Use thick cushioned gloves and limit the exposure time by taking frequent rest periods. Vibration caused by the tool may be harmful to the hands and arms.

Before scraping, check workpiece for nails. If there are nails, either remove them or set them well below intended finished surface. Striking a nail with accessory edge could cause the tool to jump.

Do not wet sand with this tool. Liquids entering the motor housing is an electrical shock hazard.

Never work in area which is soaked with a liquid, such as a solvent or water, or

dampened such as newly applied wallpaper. There is an electrical shock hazard when working in such conditions with a power tool and heating of the liquid caused by scraping action may cause harmful vapors to be emitted from workpiece.

Always wear eye protection and a dust mask for dusty applications and when sanding overhead. Sanding particles can be absorbed by your eyes and inhaled easily and may cause health complications.

Use special precautions when sanding chemically pressure treated lumber, paint that may be lead based, or any other materials that may contain carcinogens. A suitable breathing respirator and protective clothing must be worn by all persons entering the work area. Work area should be sealed by plastic sheeting and persons not protected should be kept out until work area is thoroughly cleaned.

Do not use sandpaper intended for larger sanding pads. Larger sandpaper will extend beyond the sanding pad causing snagging, tearing of the paper or kick-back. Extra paper extending beyond the sanding pad can also cause serious lacerations.

Additional Safety Warnings

Always inspect blade for damage (breakage, cracks) before each use. Never use if damage is suspected.

GFCI and personal protection devices like electrician's rubber gloves and footwear will further enhance your personal safety.

Do not use AC only rated tools with a DC power supply. While the tool may appear to work, the electrical components of the AC rated tool are likely to fail and create a hazard to the operator.

Keep handles dry, clean and free from oil and grease. Slippery hands cannot safely control the power tool.

Develop a periodic maintenance schedule for your tool. When cleaning a tool be careful not to disassemble any portion of the tool since internal wires may be misplaced or pinched or safety guard return springs may be improperly mounted. Certain cleaning agents such as gasoline, carbon tetrachloride, ammonia, etc. may damage plastic parts.

Risk of injury to user. The power cord must only be serviced by a Dremel Service Facility.

⚠️ WARNING Some dust created by power sanding, sawing, grinding, drilling, and other construction activities contains chemicals known to cause cancer, birth defects or other reproductive harm. Some examples of these chemicals are:







- Lead from lead-based paints,
- Crystalline silica from bricks and cement and other masonry products, and
- Arsenic and chromium from chemically-treated lumber.

Your risk from these exposures varies, depending on how often you do this type of work. To reduce your exposure to these chemicals: work in a well ventilated area, and work with approved safety equipment, such as those dust masks that are specially designed to filter out microscopic particles.

1600A014GX	Instruction manual	AC	6035A06F09	2018-10-09	rui1mex	511	DV	--	MUL	4 / 56
SNR	Term	Ind.	CRNo.	Valid	Release	BWN	DocType	CritP.	DP	Page / of

Symbols

IMPORTANT: Some of the following symbols may be used on your tool. Please study them and learn their meaning. Proper interpretation of these symbols will allow you to operate the tool better and safer.

Symbol	Designation / Explanation
V	Volts (voltage)
A	Amperes (current)
Hz	Hertz (frequency, cycles per second)
W	Watt (power)
kg	Kilograms (weight)
min	Minutes (time)
s	Seconds (time)
∅	Diameter (size of drill bits, grinding wheels, etc.)
n_0	No load speed (rotational speed at no load)
n	Rated speed (maximum attainable speed)
.../min	Revolutions or reciprocation per minute (revolutions, strokes, surface speed, orbits etc. per minute)
0	Off position (zero speed, zero torque...)
1, 2, 3, ... I, II, III,	Selector settings (speed, torque or position settings. Higher number means greater speed)
	Infinitely variable selector with off (speed is increasing from 0 setting)
	Arrow (action in the direction of arrow)
	Alternating current (type or a characteristic of current)
	Direct current (type or a characteristic of current)
	Alternating or direct current (type or a characteristic of current)
	Class II construction (designates double insulated construction tools)
	Earthing terminal (grounding terminal)

Symbols (continued)

IMPORTANT: Some of the following symbols may be used on your tool. Please study them and learn their meaning. Proper interpretation of these symbols will allow you to operate the tool better and safer.

Symbol	Designation / Explanation
	Designates Li-ion battery recycling program
	Designates Ni-Cad battery recycling program
	Alerts user to read manual
	Alerts user to wear eye protection
	This symbol designates that this tool is listed by Underwriters Laboratories.
	This symbol designates that this component is recognized by Underwriters Laboratories.
	This symbol designates that this tool is listed by Underwriters Laboratories, to United States and Canadian Standards.
	This symbol designates that this tool is listed by the Canadian Standards Association.
	This symbol designates that this tool is listed by the Canadian Standards Association, to United States and Canadian Standards.
	This symbol designates that this tool is listed by the Intertek Testing Services, to United States and Canadian Standards.
	This symbol designates that this tool complies to NOM Mexican Standards.

Introduction

Thank you for purchasing the Dremel Multi-Max™.

This tool was designed to tackle home repair, remodeling and restoration projects. The Dremel Multi-Max™ tackles tasks that are tedious, time consuming or simply next to impossible to achieve with any other tool. The ergonomic housing is designed for you to hold and control in a comfortable manner during operation.

It comes with an assortment of accessories that are specifically designed for remodeling work where you need precision and control.

Your Dremel Multi-Max™ has a robust electric motor, is comfortable in the hand, and is made to accept a large variety of accessories including flush cut blades, scraper blades, grout removal wheels and sanding pads.

Accessories come in a variety of shapes and permit you to do a number of different jobs. As you become familiar with the range of accessories and their uses, you will learn just how versatile your Dremel Multi-Max™ is.

Visit www.dremel.com to learn more about what you can do with your Dremel Multi-Max™.

INTENDED USE

This Dremel Multi-Max™ Tool is intended for dry sanding of surfaces, corners, edges, scraping, sawing soft metals, wood and plastic components, and grout removal using the applicable tools and accessories recommended by Dremel.

1600A014GX	Instruction manual	AC	6035A06F09	2018-10-09	511	DV	--	MUL	7 / 56
SNR	Term	Ind.	CRNo.	Valid	Release	BWN	DocType	DP	Page / of

Functional Description and Specifications

⚠ WARNING Disconnect the plug from the power source before making any assembly, adjustments or changing accessories. Such preventive safety measures reduce the risk of starting the tool accidentally.

Model MM50 Multi-Max™ Oscillating Power Tool

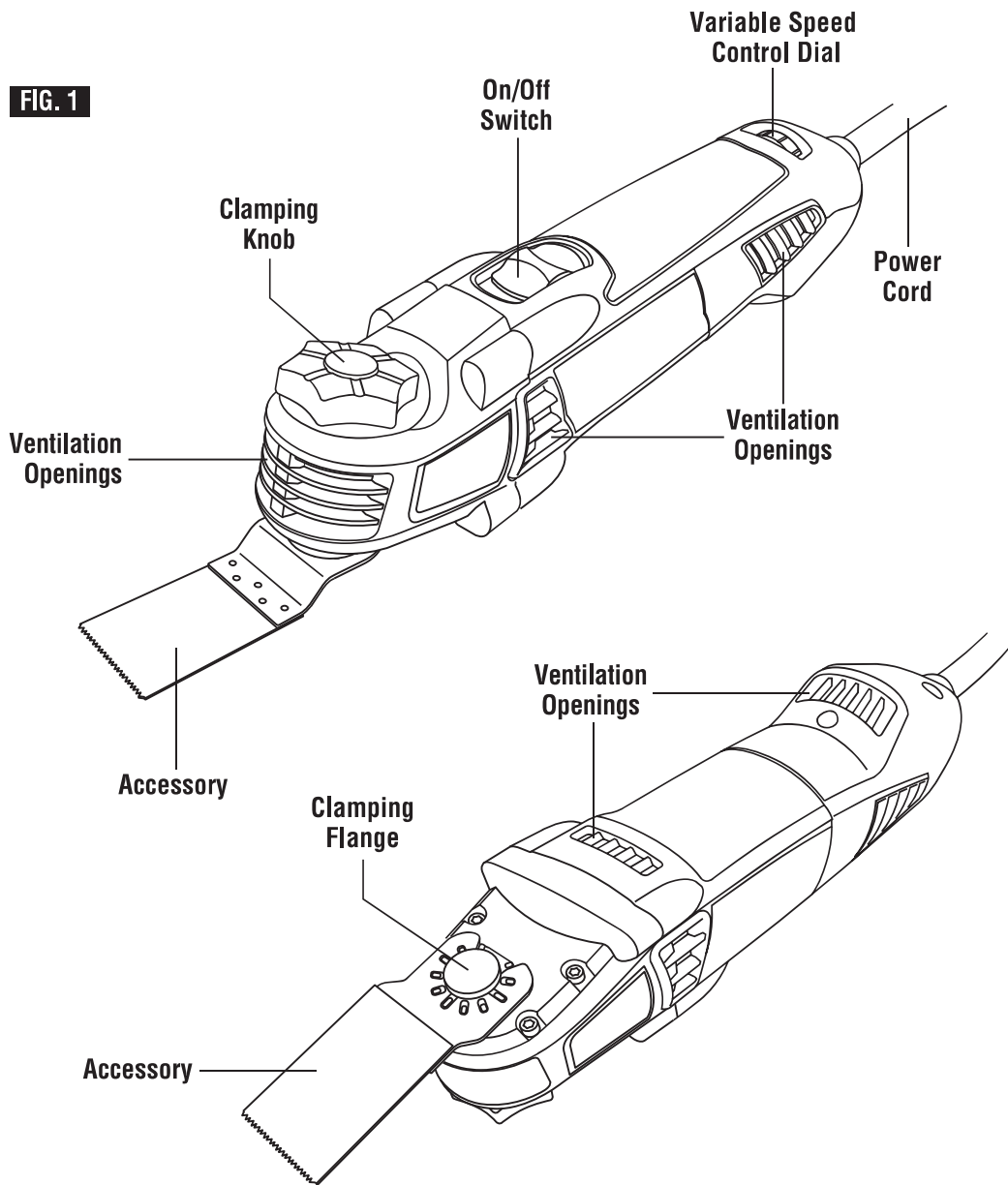

Model number	MM50
No load speed	n_0 10,000-21,000/min
Voltage rating	120 V ~ 60 Hz

NOTE: For tool specifications refer to the nameplate on your tool.

1600A014GX	SNR	Instruction manual	AC	6035A06F09	CRNo.	2018-10-09	Valid	2018-10-09	Release	511	BWN	DV	DocType	--	CritP.	MUL	DP	8 / 56	Page / of
------------	-----	--------------------	----	------------	-------	------------	-------	------------	---------	-----	-----	----	---------	----	--------	-----	----	--------	-----------

Assembly

⚠️ WARNING Disconnect the plug from the power source before making any assembly, adjustments or changing accessories. Such preventive safety measures reduce the risk of starting the tool accidentally.

⚠️ WARNING For all work or when changing accessories always wear protective gloves. Such preventive safety measures reduce the risk of injury from sharp edges of the accessories. Application tools can become very hot while working. Danger of burns!

INSTALLING ACCESSORIES WITH EASY-LOCK ACCESSORY CHANGE

⚠️ WARNING Only use Dremel accessories rated 21000 OPM or greater. Using accessories not designed for this power tool may result in serious personal injury and property damage.

The Dremel Multi-Max MM50 was designed with an integrated accessory change mechanism. The Easy-Lock accessory interface allows you to install and remove accessories without the need of a wrench or hex key.

1. To install an accessory using the Easy-Lock feature, first loosen the clamping knob by twisting it in a counter-clockwise direction (Fig. 2).
2. Press the clamping knob so that the clamping flange extends enough to fit a blade in between the clamping flange and the interface. You may need to loosen the clamping knob more to allow adequate room for the accessory. (Fig. 3)
3. Place the accessory onto the interface, making sure the accessory engages all pins on the interface and the accessory is flush against the accessory holder (Fig. 4).
4. Release pressure on the clamping knob. The spring action of the mechanism will hold the blade in place while you secure it (Fig. 5).
5. Tighten the clamping knob by twisting in a clockwise direction (Fig. 2). Make sure to tighten fully, until you can't twist the clamping knob (without it being uncomfortable).

FIG. 2

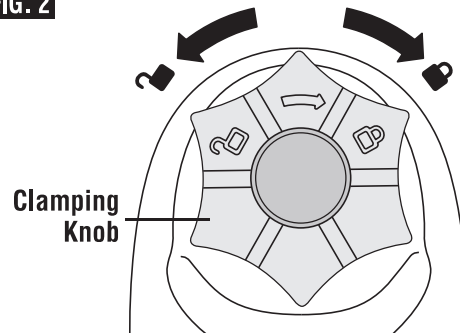

FIG. 3

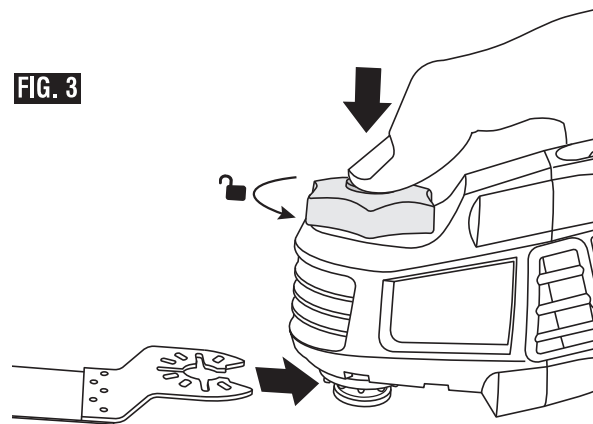

FIG. 4

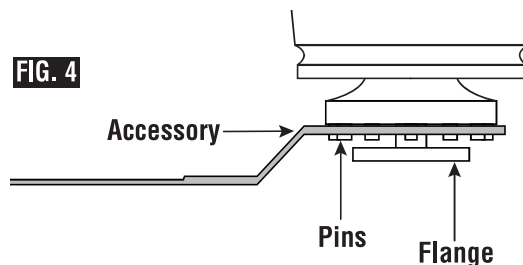
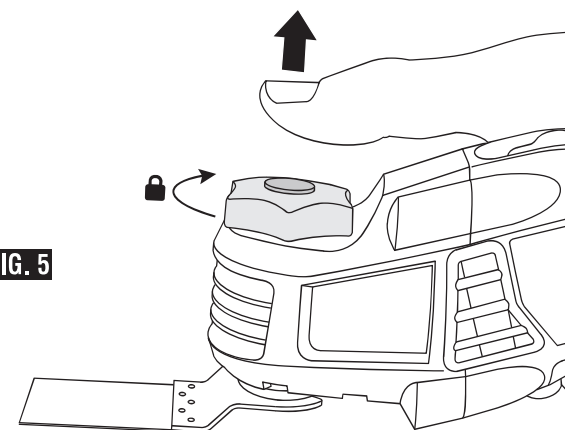

FIG. 5



Note: Some accessories, such as scrapers or blades, may be mounted either straight on the tool, or at an angle to enhance usability (Fig. 6).

In order to do this with the Easy-Lock interface, place the accessory onto the accessory holder making sure the accessory engages all pins in the holder and the accessory is flush against the accessory holder. Securely lock the accessory in place as described previously (Fig. 2).

REMOVING ACCESSORIES WITH EASY-LOCK ACCESSORY CHANGE

1. To remove an accessory, first loosen the clamping knob by twisting it in a counter-clockwise direction (Fig. 2).
2. Press the clamping knob and lift the accessory bracket to take it off the pins. You may need to loosen the clamping

FIG. 6

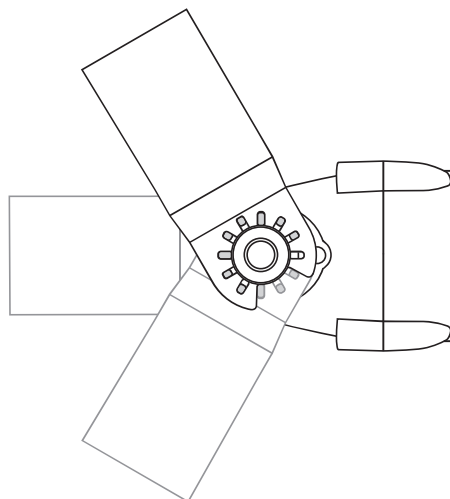

knob more to allow adequate room to remove the accessory. (Fig. 3)

Note: Blade may be hot after use, wait for blade to cool down before touch.

INSTALLING AND REMOVING SANDING SHEETS

Your backing pad uses hook-and-loop backed sandpaper, which firmly grips the backing pad when applied with moderate pressure.

1. Align the sanding sheet and press it onto the sanding plate by hand.
2. Firmly press the power tool with the sanding sheet against a flat surface and briefly switch the power tool on. This will promote good adhesion and helps to prevent premature wear.

3. To change, merely peel off the old sanding sheet, remove dust from the backing pad if necessary, and press the new sanding sheet in place.

After considerable service the backing pad surface will become worn, and the backing pad must be replaced when it no longer offers a firm grip. If you are experiencing premature wear out of the backing pad facing, decrease the amount of pressure you are applying during operation of the tool.

For maximum use of abrasive, rotate pad 120 degrees when tip of abrasive becomes worn.

Operating Instructions

LEARNING TO USE THE TOOL

Getting the most out of your oscillating tool is a matter of learning how to let the speed and the feel of the tool in your hands work for you.

The first step in learning to use the tool is to get the “feel” of it. Hold it in your hand and feel its weight and balance (Fig. 7). Depending on the application, you will need to adjust your hand position to achieve optimum comfort and control. The unique comfort grip on the body of the tool allows for added comfort and control during use.

FIG. 7

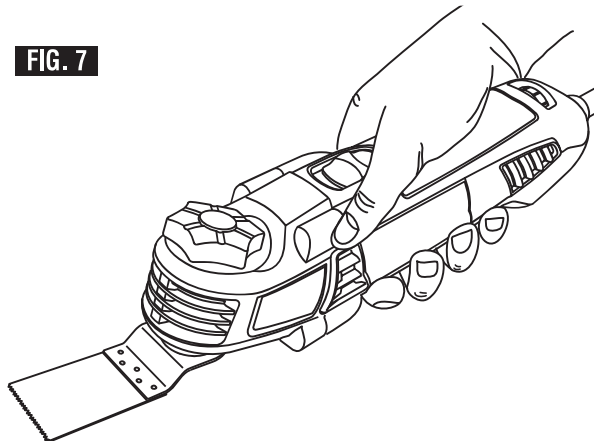

When holding tool, do not cover the air vents with your hand. Blocking the air vents could cause the motor to overheat.

IMPORTANT! Practice on scrap material first to see how the tool's high-speed action performs. Keep in mind that your tool will perform best by allowing the speed, along with the correct accessory, do the work for you. Be careful not to apply too much pressure.

Instead, lower the oscillating accessory lightly to the work surface and allow it to touch the point at which you want to begin. Concentrate on guiding the tool over the work using very little pressure from your hand. Allow the accessory to do the work.

Usually it is better to make a series of passes with the tool rather than to do the entire job with one pass. To make a cut, for example, pass the tool back and forth over the work. Cut a little material on each pass until you reach the desired depth.

SLIDE "ON/OFF" SWITCH

The tool is switched "ON" by the slide switch located on the topside of the motor housing.

TO TURN THE TOOL "ON", slide the switch button forward.

TO TURN THE TOOL "OFF", slide the switch button backward.

VARIABLE SPEED CONTROL DIAL

This tool is equipped with a variable speed control dial (Fig. 7). The speed may be controlled during operation by presetting the dial in any one of ten positions.

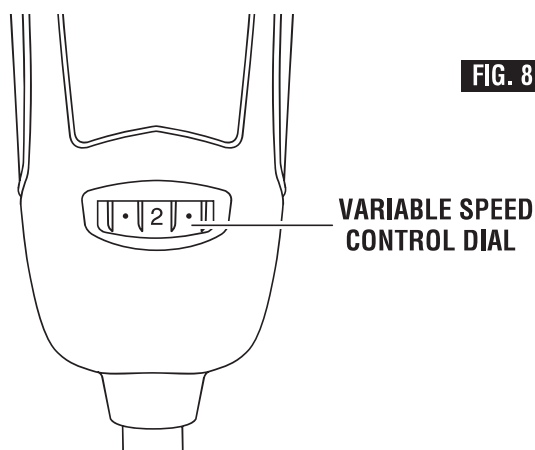

OPERATING SPEEDS

The Dremel Multi-Max™ consists of an AC universal motor and oscillating mechanism to perform applications such as cutting, grout removal, scraping, sanding and more.

The Dremel Multi-Max™ has a high oscillating motion of 10,000 - 21,000 /min (OPM). The high speed motion allows the Dremel Multi-Max™ to achieve with excellent results. The oscillating motion allows the dust to fall to the surface rather than slinging particles into the air.

To achieve the best results when working with different materials, set the variable speed control to suit the job (See Speed Chart on Page 13 & 14 for guidance). To select the right speed for the accessory in use, practice with scrap material first.

NOTE: Speed is affected by voltages changes. A reduced incoming voltage will slow the OPM of the tool, especially at the lowest setting. If your tool appears to be running slowly, increase the speed setting accordingly. The tool may not start at the lowest switch setting in areas where outlet voltage is less than 120 volts. Simply move the speed setting to a higher position to begin operation.

The variable speed control settings are marked on the speed control dial. The settings for approximate speed range /min (OPM) are:

Speed Control Dial Setting	Speed Range /min (OPM)
2	10,000-11,000
4	11,000-13,000
6	13,000-16,000
8	16,000-19,000
10	19,000-21,000

You can refer to the charts on the following pages to determine the proper speed, based on the material and accessory being used. These charts enable you to select both the correct accessory and the optimum speed at a glance.

1600A014GX	Instruction manual	AC	6035A06F09	2018-10-09	511	DV	--	MUL	11 / 56
SNR	Term	Ind.	CRNo.	Valid	Release	DocType	CritP.	DP	Page / of

Please refer to figures 9 and 10 for further instruction on how to use your Dremel Multi-Max™. Following these instructions will allow you to get the highest performance out of your oscillating tool.

FIG. 9

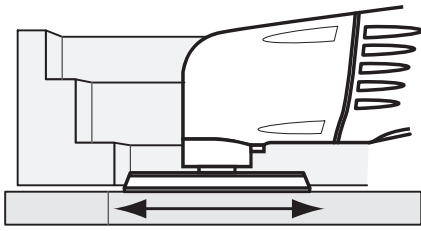

CORRECT: Sand with a smooth back and forth motion, allowing the weight of the tool to do the work.

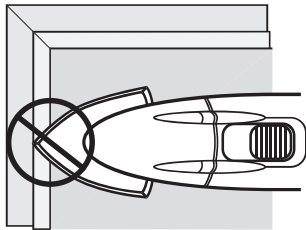

INCORRECT: Avoid sanding with only the tip of the pad. Keep as much sand paper in touch with the work surface as possible.

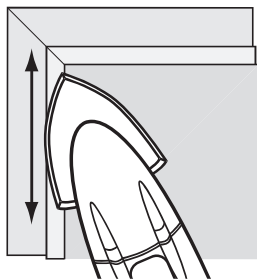

CORRECT: Always sand with the pad and sandpaper flat against the work surface. Work smoothly in a back and forth motion.

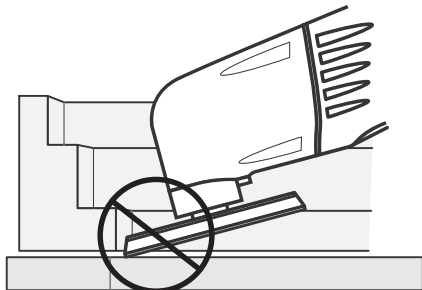

INCORRECT: Avoid tipping the pad. Always sand flat.

FIG. 10

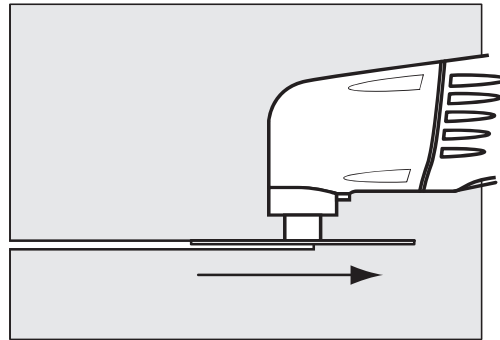

CORRECT: Always cut with a smooth back and forth motion. Never force the blade. Apply light pressure to guide the tool.

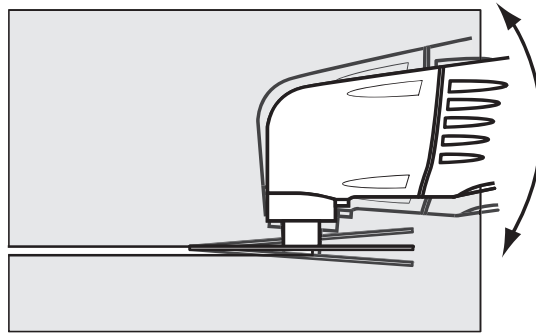

INCORRECT: Do not twist the tool while cutting. This can cause the blade to bind.

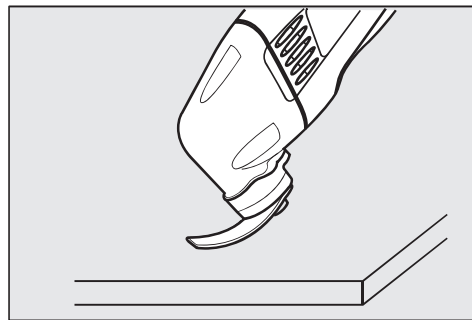

CORRECT: Make sure flexible scraper blade flexes enough

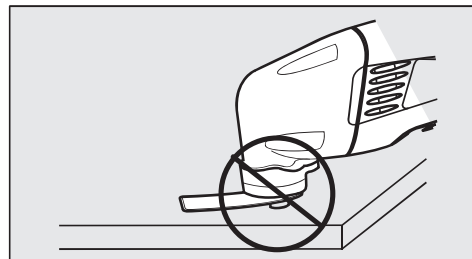







INCORRECT: Avoid screw head touching surface with flexible scraper blade.

1600A014GX	Instruction manual	AC	6035A06F09	2018-10-09	rui1mex	511	DV	--	MUL	12 / 56
SNR	Term	Ind.	CRNo.	Valid	Release	BWN	DocType	CritP.	DP	Page / of

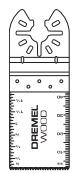
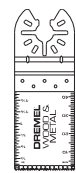
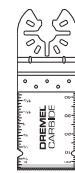
Accessories & Variable Speed Control Dial Settings

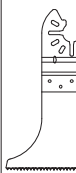





Use only Dremel, high-performance accessories.

	Description	Catalog Number	Soft Wood	Hard Wood	Painted Wood	Laminates	Steel	Aluminum/Copper	Vinyl/Carpet	Caulk/Adhesive	Stone/Cement	Grout
	60, 120, 240 Grit Paper - Bare Wood	MM70W	2 - 10	2 - 10	-	2 - 6	8 - 10	8 - 10	-	-	-	-
	60, 120, 240 Grit Paper - Paint	MM70P	2 - 10	2 - 10	2 - 10	2 - 6	8 - 10	8 - 10	-	-	-	-
	HCS Wood Flush Cut Blade 1-1/4" X 1-11/16"	MM480	8 - 10	6 - 10	-	2 - 6	-	-	-	-	-	-
	BiM Wood & Metal Flush Cut Blade 1-1/4" X 1-11/16"	MM482	8 - 10	6 - 10	-	2 - 6	8 - 10*	8 - 10	-	-	-	-
	Carbide Flush Cut Blade 1-1/4" X 1-11/16"	MM485	8 - 10	6 - 10	-	2 - 6	8 - 10	8 - 10	-	-	-	-
	BiM Wood & Metal Flush Cut Panel Blade	VC490	8 - 10	6 - 10	-	2 - 6	8 - 10*	8 - 10	-	-	-	-
	BiM Wood & Metal Flush Cut Pipe & 2x4 Blade	VC494	8 - 10	6 - 10	-	2 - 6	8 - 10*	8 - 10	-	-	-	-
	3" Wood & Drywall Saw Blade	MM450	8 - 10	6 - 10	-	2 - 6	-	-	-	-	-	-
	3" BiM Wood & Metal Flush Cut Saw Blade	MM452	8 - 10	6 - 10	-	2 - 6	8 - 10*	8 - 10	-	-	-	-

* Soft Steel Only

Accessories & Variable Speed Control Dial Settings

Use only Dremel, high-performance accessories.

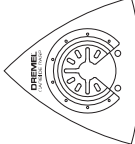
	Description	Catalog Number	Soft Wood	Hard Wood	Painted Wood	Laminates	Steel	Aluminum/ Copper	Vinyl/ Carpet	Caulk/ Adhesive	Stone/ Cement	Grout
	Multi-Knife Blade	MM430	-	-	-	-	-	-	6 - 10	-	-	-
	1/8" Grout Removal Blade	MM500	-	-	-	-	-	-	-	-	-	6 - 10
	1/16" Grout Removal Blade	MM501	-	-	-	-	-	-	-	-	-	6 - 10
	1/16" Grout Removal Blade	MM502	-	-	-	-	-	-	-	-	-	6 - 10
	Rigid Scraper Blade	MM600	-	-	2 - 4	-	-	-	2 - 6	2 - 6	-	-
	Flexible Scraper Blade	MM610	-	-	2 - 4	-	-	-	-	2 - 6	-	-
	60 Grit Diamond Paper	MM910	-	-	-	-	-	-	-	-	6 - 10	6 - 10
	24 Grit Carbide Rasp	MM920	6 - 10	6 - 10	6 - 10	-	-	-	-	-	6 - 10	6 - 10

Operating Applications

APPLICATION

Your Dremel Multi-Max™ Tool is intended for sanding and cutting wooden materials, plastic, plaster and non-ferrous metals. It is especially suitable for working close to edges, in tight spaces, and for flush cutting. This tool must be used only with Dremel accessories .

Below are some typical uses for your Dremel Multi-Max™ Tool.

⚠ WARNING For all accessories, work with the accessory away from the body. Never position hand near or directly in front of working area. Always hold the tool with both hands and wear protective gloves.

Flush Cutting

Remove excess wood from door jamb, window sill and/or toekick. Removing excess copper or PVC pipe.

Removal work

e.g. carpets & backing, old tile adhesives, caulking on masonry, wood and other surfaces.

Removal of excess materials

e.g. plaster, mortar splatters, concrete on tiles, sills.

Preparation of surfaces

e.g. for new floors and tiles.

Detail sanding

e.g. for sanding in extremely tight areas otherwise difficult to reach and require hand sanding

CUTTING

Saw blades are ideal for making precise cuts in tight areas, close to edges or flush to a surface.

Select a medium to high speed for making initial plunge, start off at medium speed for increased control. After making your initial cut, you can increase speed for faster cutting ability.

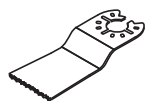

Flush cutting blades are intended to make precise cuts to allow for installation of flooring or wall material. When flush cutting it is important not to force the tool during the plunge cut. If you experience a strong vibration in your hand during the plunge cut, this indicates that you are applying too much pressure. Back the tool out and let the speed of the tool do the work. While keeping the teeth

of the blade in the work surface, move the back of the tool in a slow sideways motion. This motion will help expedite the cut.

When making a flush cut it is always a good idea to have a piece of scrap material (tile or wood) supporting the blade. If you need to rest the flush cutting blade on a delicate surface, you should protect the surface with cardboard or masking tape.



The flat saw blade is ideal for making precise cuts in wood, plaster, drywall material.

Applications include cutting openings in flooring for venting, repairing damaged flooring, cutting openings for electrical boxes. The blade works best on softer woods such as pine. For harder woods, the blade life will be limited.

Select a medium to high speed.

The flat saw blade can also be used for window restoration making glazing easy to remove. The saw blade can be placed directly against the edge of the window frame, guiding the blade through the glazing.

Panel Cutting Accessory Model VC490

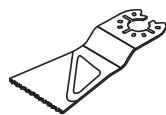

The panel blade has been designed for making straight cuts in sheet materials, such as plywood, drywall and cement board up to 3/4" thick. (Refer to chart for cutting depths.) For best results, this blade should be used with the tools control foot in the open position. This blade has a more rigid design to help improve accuracy and control when making these types of cuts. When making cuts in sheet materials it is important not to force the tool during the cut. If you experience strong vibration in your hand during the cut, this indicates that you are applying too much pressure. Back the tool out of the cut and let the speed of the tool do the work.

Pipe and 2x4 Cutting Accessory Model VC494



The pipe and 2x4 cutting blade has been designed to cut through thick materials, such as a 2x4, as well as tubing, such as conduit, copper and PVC piping.

1600A014GX	Instruction manual	AC	6035A06F09	2018-10-09	511	DV	--	MUL	15 / 56
SNR	Term	Ind.	CRNo.	Valid	BWN	DocType	CritP.	DP	Page / of

GROUT REMOVAL



Grout removal blades are ideal for removing damaged or cracked grout. Grout blades come in different widths (1/16" and 1/8") to tackle different grout line widths. Before selecting a grout blade measure the grout line width to pick the appropriate blade.

Select a medium to high speed.

To remove the grout, use a back and forth motion, making several passes along the grout line. The hardness of the grout will dictate how many passes are needed. Try and keep the grout blade aligned with the grout line and be careful not to apply too much side pressure on the grout blade during the process. To control plunge depth use the carbide grit line on the blade as an indicator. Be careful not to plunge beyond the carbide grit line to avoid damage to the backer board material.

The grout blades can handle both sanded and unsanded grout. If you notice the blade clogging during the grout removal process, you can use a brass brush to clean the grit, thus exposing the grit again.

The grout blade geometry is designed so that the blade can remove all grout up to the surface of a wall or corner. This can be accomplished by ensuring that the segmented portion of the blade is facing the wall or corner.

SCRAPING

Scrapers are suitable for removing old coats of varnish or adhesives, removing bonded carpeting, e.g. on stairs/steps and other small/medium size surfaces.

Select low to medium speed.



Rigid scrapers are for large area removal, and harder materials such as vinyl flooring, carpeting and tile adhesives. When removing strong, tacky adhesives, **grease the scraper blade surface with (petroleum jelly or silicone grease) to reduce gumming up.**

The carpet/vinyl flooring removes easier if it is scored prior to removal so the scraper blade can move underneath the flooring material.

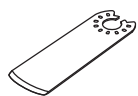

Flexible scrapers are used for hard to reach areas and softer material such as caulk.

Mount the scraper blade with the logo side facing up. With the flexible scraper, make sure that the screw head does not make contact with surface during the scraping process (a 30 - 45 degree pitch is recommend). This can be

accomplished by making sure that the tool is at an angle to the blade. You should be able to see the blade flex during the scraping process.

If you are removing caulk from a delicate surface such as a bath tub or tile back splash, we recommend taping or protecting the surface that the blade will rest on. Use rubbing alcohol to clean the surface after the caulk and/or adhesive is removed.

Turn the tool on and place desired accessory on the area where material is to be removed.

Begin with light pressure. The oscillating motion of accessory only occurs when pressure is applied to the material to be removed.

Excessive pressure can gouge or damage the background surfaces (e.g., wood, plaster).

SANDING



Sanding accessories are suitable for dry sanding of wood, metal, surfaces, corners and edges and hard to reach areas.

Work with the complete surface of the sanding pad, not only with the tip.

Corners may be finished using the tip or edge of the selected accessory, which should occasionally be rotated during use to distribute the wear on the accessory and backing pad surface.

Sand with a continuous motion and light pressure. **DO NOT** apply excessive pressure - let the tool do the work. Excessive pressure will result in poor handling, vibration, and unwanted sanding marks and premature wear on the sanding sheet.

Always be certain that smaller workpieces are securely fastened to a bench or other support. Larger panels may be held in place by hand on a bench or sawhorses.

Open-coat aluminum oxide sanding sheets are recommended for most wood or metal sanding applications, as this synthetic material cuts quickly and wears well. Some applications, such as metal finishing or cleaning, require special abrasive pads which are available from your dealer. For best results, use Dremel sanding accessories which are of superior quality and are carefully selected to produce professional quality results with your oscillating tool.

The following suggestions may be used as a general guide for abrasive selection, but the best results will be obtained by sanding a test sample of the workpiece first.

1600A014GX	Instruction manual	AC	6035A06F09	2018-10-09	rui1mex	511	DV	--	MUL	16 / 56
SNR	Term	Ind.	CRNo.	Valid	Release	BWN	DocType	CritP.	DP	Page / of

Grit	Application
Coarse	For rough wood or metal sanding, and rust or old finish removal.
Medium	For general wood or metal sanding
Fine	For final finishing of wood, metal, plaster and other surfaces.

With the workpiece firmly secured, turn tool on as described above. Contact the work with the tool after the tool has reached its full speed, and remove it from the work before switching the tool off. Operating your oscillating tool in this manner will prolong switch and motor life, and greatly increase the quality of your work.

Move the oscillating tool in long steady strokes parallel to the grain using some lateral motion to overlap the strokes by as much as 75%. DO NOT apply excessive pressure - let the tool do the work. Excessive pressure will result in poor handling, vibration, and unwanted sanding marks.

GRINDING

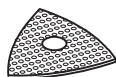

The diamond paper accessory allows for the Multi-Max™ to be used for grinding away cement, plaster or thin set. Preparing the surface for tile replacement is a common application for this accessory.

The diamond paper needs to be mounted to the backing pad prior to use.

Select a low to high speed depending on the material removal rate desired.





The carbide rasp accessory also allows the Multi-Max™ to grind away cement, thinset mortar, plaster, and also wood. This accessory is commonly used to prepare for tile replacement or rasping wood to smooth a surface or remove material.

The speed should be set at high speed for aggressive material removal or at low speed for a more detailed removal of material.

Do not apply excessive pressure on the tool-let it do the work.

Corners may be finished using the tip or edge of the selected accessory, which should occasionally be rotated during use to distribute the wear on the accessory and backing pad surface.

Grind with a continuous motion and light pressure. DO NOT apply excessive pressure - let the tool do the work. Excessive pressure will result in poor handling, vibration, and premature wear on the diamond paper sheet.

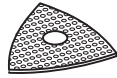
Selecting Sanding / Grinding Sheets			
Material	Application	Grit Size	
All wooden materials (e.g., hardwood, softwood, chipboard, building board) Metal materials— Metal materials, fiberglass and plastics  Sand Paper (Dark)	For coarse-sanding, e.g. of rough, unplanned beams and boards	Coarse	60
	For face sanding and planing small irregularities	Medium	120
	For finish and fine sanding of wood	Fine	240
Paint, varnish, filling compound, and filler  Sand Paper (White)	For sanding off paint	Coarse	80
	For sanding primer (e.g., for removing brush dashes, drops of paint and paint run)	Medium	120
	For final sanding of primers before coating	Fine	240
Masonry, stone, cement and thin set  Diamond Paper	For smoothing, shaping and braking edges	Coarse	60

1600A014GX	Instruction manual	AC	6035A06F09	2018-10-09	511	DV	--	MUL	17 / 56
SNR	Term	Ind.	CRNo.	Valid	BWN	DocType	CritP.	DP	Page / of

Maintenance Information

Service

⚠️ WARNING NO USER SERVICEABLE PARTS INSIDE. Preventive maintenance performed by unauthorized personnel may result in misplacing of internal wires and components which could cause serious hazard. We recommend that all tool service be performed by a Dremel Service Facility.

CARBON BRUSHES

The brushes and commutator in your tool have been engineered for many hours of dependable service. To maintain peak efficiency of the motor, we recommend every 50 - 60 hours the brushes be serviced by a Dremel Service Facility.

Cleaning

⚠️ WARNING To avoid accidents always disconnect the tool from the power supply before cleaning or performing any maintenance. The tool may be cleaned most effectively with compressed dry air. **Always wear safety goggles when cleaning tools with compressed air.**

Ventilation openings and switch levers must be kept clean and free of foreign matter. Do not attempt to clean by inserting pointed objects through openings.

⚠️ CAUTION Certain cleaning agents and solvents damage plastic parts. Some of these are: gasoline, carbon tetrachloride, chlorinated cleaning solvents, ammonia and household detergents that contain ammonia.

Extension Cords

⚠️ WARNING If an extension cord is necessary, a cord with adequate size conductors that is capable of carrying the current necessary for your tool must be used. This will prevent excessive voltage drop, loss of power or overheating. Grounded tools must use 3-wire extension cords that have 3-prong plugs and receptacles.

NOTE: The smaller the gauge number, the heavier the cord.

RECOMMENDED SIZES OF EXTENSION CORDS 120 VOLT ALTERNATING CURRENT TOOLS

Tool's Ampere Rating	Cord Size in A.W.G.				Wire Sizes in mm ²			
	Cord Length in Feet				Cord Length in Meters			
	25	50	100	150	15	30	60	120
3-6	18	16	16	14	0.75	0.75	1.5	2.5
6-8	18	16	14	12	0.75	1.0	2.5	4.0
8-10	18	16	14	12	0.75	1.0	2.5	4.0
10-12	16	16	14	12	1.0	2.5	4.0	-
12-16	14	12	-	-	-	-	-	-

1600A014GX	Instruction manual	AC	6035A06F09	2018-10-09	511	DV	--	MUL	18 / 56
SNR	Term	Ind.	CRNo.	Valid	Release	BWN	CritP.	DP	Page / of